



Floor drains and industrial drainage channels

- types of gratings
- technical informations
- technology and materials



Table of Content

Single-part H. Design square floor drain

 [Click to](#) browse the category

Two-part H. Design square floor drain

Single-part H. Design round floor drain

Two-part H. Design round floor drain

Table of Content

 [Click to](#) browse the category



bim.att.eu

Single-part H. Design square floor drain (200 x 200 mm) W200 / DN75 V1, H1 / DN110 V1, H1

ATT stainless steel floor drain features:



Vertical outlet DN75 or DN110



Horizontal outlet DN75 or DN110

- the drain is manufactured according to EN 1253 and EHEDG guidelines
- square shape,
- upper part of the body 200 x 200 mm,
- hygienically deep-pressed body without sharp corners or elements,
- rounded body diameter: 157 mm,
- no fluid backing up in the floor drain's body,
- flow rate 2.1 l/s,
- siphon with EPDM gasket,
- height of the water column is 50 mm,
- waste basket (capacity 0.45l) with handle,
- top edge brushed,
- M10 adjustment screws,
- material EN 1.4301, AISI 304 or EN 1.4404, AISI 316L,
- sheet thickness: 1.5 mm and 1.2 mm,
- pickled and passivated surface.



Water trap



Waste basket



Sand basket

Grating of floor drain floor

(200 x 200 mm) W200 / DN75 V1, H1 / DN110 V1, H1

Mesh grating, with 25 x 25mm mesh, with R13 anti-slip surface according to DIN 51130. Meets the requirements of load class L15 according to EN 1253.

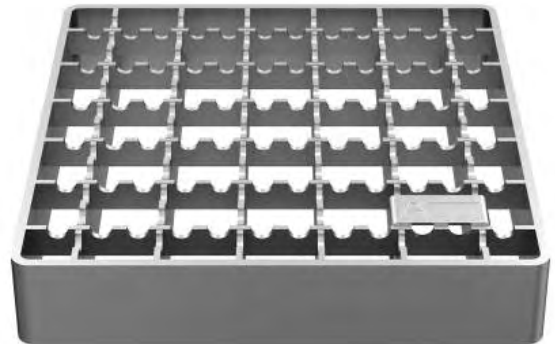

Slab grate with side gap, easy to remove. R10 anti-slip surface in accordance with DIN 51130. Meets the requirements of load class M125 in accordance with EN 1253.



Ladder grate with smooth, non-slip surface R9 in accordance with DIN 51130. Meets the requirements of load class M125 in accordance with EN 1253. Complete welding in accordance with EHEDG compliant.



Single-part H. Design square floor drain (250 x 250 mm) W250 / DN110 V1, H1

ATT stainless steel floor drain features:



Vertical outlet DN110



Horizontal outlet DN110

- the drain is manufactured according to EN 1253 and EHEDG guidelines
- square shape,
- upper part of the body 250 x 250 mm,
- hygienically deep-pressed body without sharp corners or elements,
- rounded body diameter: 193 mm,
- flow rate V1 - 3.0 l/s, H1 - 2.1 l/s.
- siphon with EPDM gasket
- height of the water column is 50 mm,
- waste basket (capacity 1l) with handle,
- top edge brushed,
- M10 adjustment screws,
- material EN 1.4301, AISI 304 or EN 1.4404, AISI 316L,
- sheet thickness: 1.5 mm,
- pickled and passivated surface.



Water trap

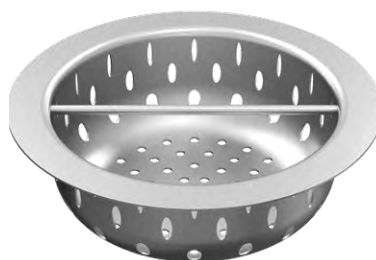

Waste basket



Sand basket

Grating of floor drain floor (250 x 250 mm) W250 / DN110 V1, H1

Mesh grating, with 25 x 25mm mesh, with R13 anti-slip surface according to DIN 51130. Meets the requirements of load class L15 according to EN 1253.

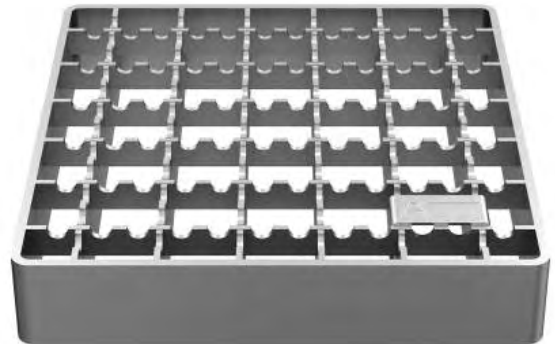

Slab grate with side gap, easy to remove. R10 anti-slip surface in accordance with DIN 51130. Meets the requirements of load class M125 in accordance with EN 1253.



Ladder grate with smooth, non-slip surface R9 in accordance with DIN 51130. Meets the requirements of load class M125 in accordance with EN 1253. Complete welding in accordance with EHEDG compliant.



Single-part H. Design square floor drain (300 x 300 mm) W300 DN110 V1, H1 / DN160 V1, H1

ATT stainless steel floor drain features:



Vertical outlet DN110 or DN160



Horizontal outlet DN110 or DN160

- the drain is manufactured according to EN 1253 and EHEDG guidelines
- square shape,
- upper part of the body 300 x 300 mm,
- hygienically deep-pressed body without sharp corners or elements,
- rounded body diameter: 255 mm,
- no fluid backing up in the floor drain's body,
- flow rate 5,7 l/s,
- siphon with EPDM gasket,
- height of the water column is 50 mm,
- waste basket (capacity 2,9 l) with handle,
- top edge brushed,
- M10 adjustment screws,
- material EN 1.4301, AISI 304 or EN 1.4404, AISI 316L,
- sheet thickness: 1.5 mm and 1.2,
- pickled and passivated surface.



Water trap

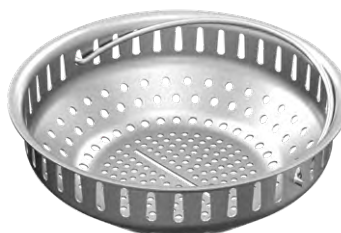

Waste basket



Sand basket

Grating of floor drain

(300 x 300 mm) W300 DN110 V1, H1 / DN160 V1, H1

Mesh grating, with 25 x 25mm mesh, with R13 anti-slip surface according to DIN 51130. Meets the requirements of load class L15 according to EN 1253.

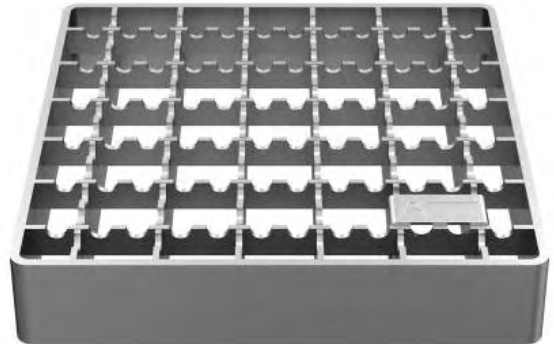

Slab grate with side gap, easy to remove. R10 anti-slip surface in accordance with DIN 51130. Meets the requirements of load class M125 in accordance with EN 1253.



Ladder grate with smooth, non-slip surface R9 in accordance with DIN 51130. Meets the requirements of load class M125 in accordance with EN 1253. Complete welding in accordance with EHEDG compliant.



Single-part H. Design square floor drain (400 x 400 mm) W400 / DN200 V1, H1

ATT stainless steel floor drain features:



Vertical outlet DN200



Horizontal outlet DN200

- the drain is manufactured according to EN 1253 and EHEDG guidelines
- square shape,
- upper part of the body 400 x 400 mm,
- rounded body diameter: 348 mm,
- flow rate V1 - 13,9 l/s, H1 - 9.2 l/s,
- siphon with EPDM gasket,
- height of the water column is 50 mm according to EN 125,
- waste basket (V1 - 8.7 l, H1 - 2.7 l) with handle,
- top edge brushed,
- M10 adjustment screws,
- material EN 1.4301, AISI 304 or EN 1.4404, AISI 316L,
- sheet thickness: 1.5 mm
- pickled and passivated surface.



Water trap



Waste basket



Sand basket



Grating of floor drain

(400 x 400 mm) W400 / DN200 V1, H1

Mesh grating, with 25 x 25 mm mesh, with R13 anti-slip surface according to DIN 51130. Meets the requirements of load class L15 according to EN 1253.

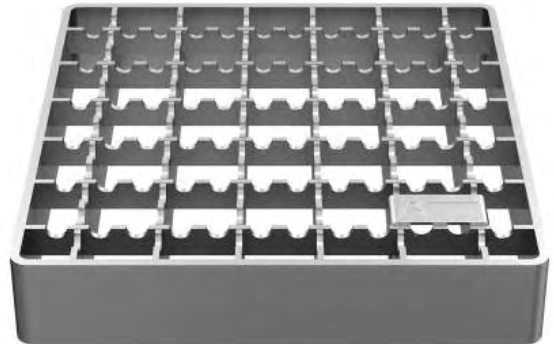

Slab grate with side gap, easy to remove. R10 anti-slip surface in accordance with DIN 51130. Meets the requirements of load class M125 in accordance with EN 1253.



Ladder grate with smooth, non-slip surface R9 in accordance with DIN 51130. Meets the requirements of load class M125 in accordance with EN 1253. Complete welding in accordance with EHEDG compliant.



Two-part H. Design square floor drain (200 x 200 mm) W200 / DN75 V2, H2 / DN110 V2, H2

ATT stainless steel floor drain features:



Vertical outlet DN75 or DN110

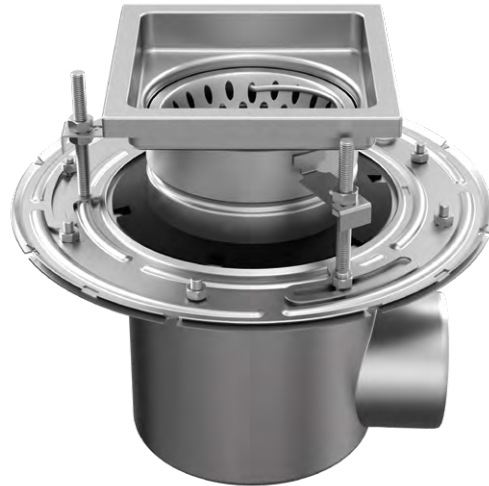

Horizontal outlet DN75 or DN110

- the drain is manufactured according to EN 1253 and EHEDG guidelines
- square shape,
- upper part of the body 200x200 mm,
- hygienically deep-pressed body without sharp corners or elements,
- bottom body diameter: 193 mm,
- height adjustable from 80 to 135 mm, possibility of rotation 360° and tilting by 6°,
- no fluid backing up in the floor drain's body,
- flow rate 2.1 l/s,
- siphon with EPDM gasket,
- height of the water column is 50 mm,
- waste basket (capacity 0.45l) with handle,
- top edge brushed,
- M10 adjustment screws,
- material EN 1.4301, AISI 304 or EN 1.4404, AISI 316L,
- sheet thickness: 1.5 mm and 1.2 mm.



Water trap



Waste basket



Sand basket

Grating of the floor drain

(200 x 200 mm) W200 / DN75 V2, H2 / DN110 V2, H2

Mesh grating, with 25 x 25mm mesh, with R13 anti-slip surface according to DIN 51130. Meets the requirements of load class L15 according to EN 1253.

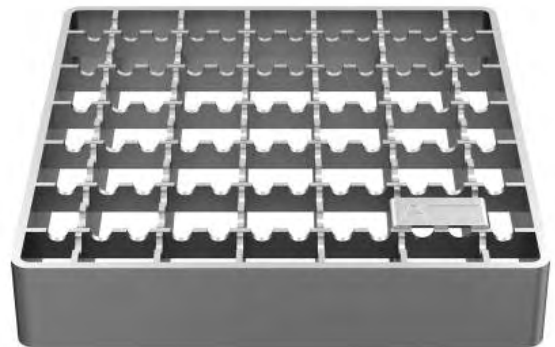

Slab grate with side gap, easy to remove. R10 anti-slip surface in accordance with DIN 51130. Meets the requirements of load class M125 in accordance with EN 1253.



Ladder grate with smooth, non-slip surface R9 in accordance with DIN 51130. Meets the requirements of load class M125 in accordance with EN 1253. Complete welding in accordance with EHEDG compliant.



Two-part H. Design square floor drain (250 x 250 mm) W250 / DN110 V2, H2

ATT stainless steel floor drain features:



Vertical outlet DN110



Horizontal outlet DN110

- the drain is manufactured according to EN 1253 and EHEDG guidelines
- square shape,
- upper part of the body 250 x 250 mm,
- hygienically deep-pressed body without sharp corners or elements,
- bottom body diameter: 193 mm,
- height adjustable from 80 to 155 mm, possibility of rotation 360° and tilting by 6°,
- flow rate V2 - 3.0 l/s, H2 - 2.1 l/s,
- siphon with EPDM gasket,
- height of the water column is 50 mm,
- waste basket (capacity 1 l) with handle,
- top edge brushed,
- M10 adjustment screws,
- material EN 1.4301, AISI 304 or EN 1.4404, AISI 316L,
- sheet thickness: 1.5 mm and 1.2 mm.



Water trap

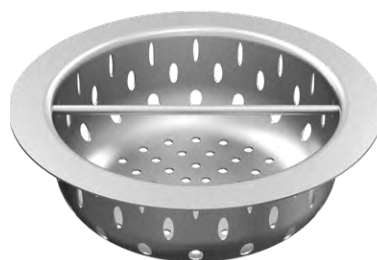

Waste basket



Sand basket

Grating of the floor drain (250 x 250 mm) W250 / DN110 V2, H2

Mesh grating, with 25 x 25 mm mesh, with R13 anti-slip surface according to DIN 51130. Meets the requirements of load class L15 according to EN 1253.

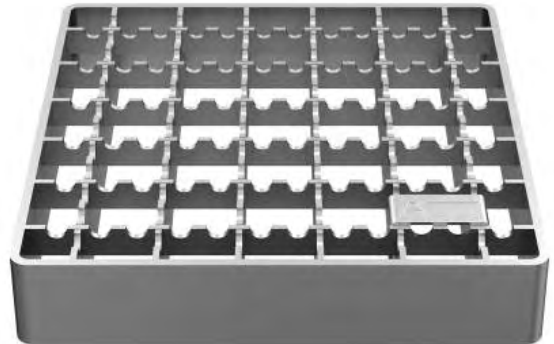

Slab grate with side gap, easy to remove. R10 anti-slip surface in accordance with DIN 51130. Meets the requirements of load class M125 in accordance with EN 1253.



Ladder grate with smooth, non-slip surface R9 in accordance with DIN 51130. Meets the requirements of load class M125 in accordance with EN 1253. Complete welding in accordance with EHEDG compliant.



Two-part H. Design square floor drain (300 x 300 mm) W300 / DN110 V2/H2 / DN160 V2/H2

ATT stainless steel floor drain features:



Vertical outlet DN110 or DN160



Horizontal outlet DN110 or DN160

- the drain is manufactured according to EN 1253 and EHEDG guidelines
- square shape,
- upper part of the body 300 x 300 mm,
- hygienically deep-pressed body without sharp corners or elements,
- bottom body diameter: 255 mm,
- height adjustable from 80 to 155 mm, possibility of rotation 360° and tilting by 6°,
- no fluid backing up in the floor drain's body
- flow rate V1, H2 - 5,7 l/s,
- siphon with EPDM gasket,
- height of the water column is 50 mm,
- waste basket (capacity 2,9 l) with handle,
- top edge brushed,
- M10 adjustment screws,
- material EN 1.4301, AISI 304 or EN 1.4404, AISI 316L,
- sheet thickness: 1.5 mm and 1.2 mm.



Water trap



Waste basket



Sand basket

Grating of the floor drain

(300 x 300 mm) W300 / DN110 V2/H2 / DN160 V2/H2

Mesh grating, with 25 x 25 mm mesh, with R13 anti-slip surface according to DIN 51130. Meets the requirements of load class L15 according to EN 1253.

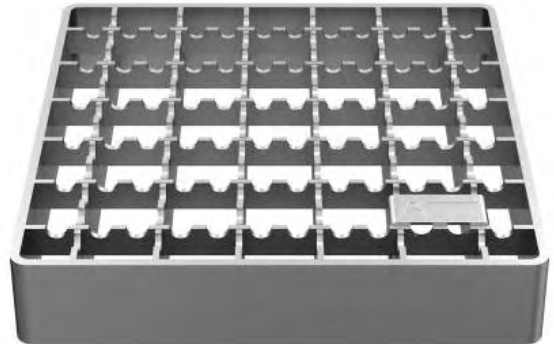

Slab grate with side gap, easy to remove. R10 anti-slip surface in accordance with DIN 51130. Meets the requirements of load class M125 in accordance with EN 1253.



Ladder grate with smooth, non-slip surface R9 in accordance with DIN 51130. Meets the requirements of load class M125 in accordance with EN 1253. Complete welding in accordance with EHEDG compliant.



Two-part H. Design square floor drain (400 x 400 mm) W400 / DN200 V2/H2

ATT stainless steel floor drain features:



Vertical outlet DN200



Horizontal outlet DN200

- the drain is manufactured according to EN 1253 and EHEDG guidelines
- square shape,
- upper part of the body 400 x 400 mm,
- bottom body diameter: 348 mm,
- height adjustable from 75 to 140 mm, possibility of rotation 360° and tilting by 6°,
- flow rate V2 - 13,9 l/s, H2 - 9,2 l/s,
- siphon with EPDM gasket,
- height of the water column is 50 mm,
- waste basket (capacity 5,4 l) with handle,
- top edge brushed,
- M10 adjustment screws,
- material EN 1.4301, AISI 304 or EN 1.4404, AISI 316L,
- sheet thickness: 1.5 mm.



Syphons



Waste basket



Sand basket



Grating of the floor drain (400 x 400 mm) W400 / DN200 V2/H2

Mesh grating, with 25 x 25 mm mesh, with R13 anti-slip surface according to DIN 51130. Meets the requirements of load class L15 according to EN 1253.

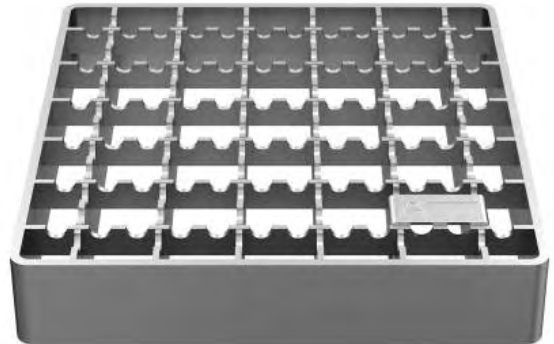

Slab grate with side gap, easy to remove. R10 anti-slip surface in accordance with DIN 51130. Meets the requirements of load class M125 in accordance with EN 1253.



Ladder grate with smooth, non-slip surface R9 in accordance with DIN 51130. Meets the requirements of load class M125 in accordance with EN 1253. Complete welding in accordance with EHEDG compliant.



Single-part H. Design round floor drain (Ø200 mm) D200 DN75 V1/H1, DN110 V1/H1

ATT stainless steel floor drain features:



Vertical outlet DN75 and DN110



Horizontal outlet DN75 and DN110

- the drain is manufactured according to EN 1253 and EHEDG guidelines
- round shape,
- upper part of the body D200 mm,
- hygienically deep-pressed body without sharp corners or elements,
- bottom body diameter: 157 mm,
- no fluid backing up in the floor drain's body
- flow rate 2,1 l/s,
- siphon with EPDM gasket,
- height of the water column is 50 mm,
- waste basket (capacity 0.45 l) with handle,
- top edge brushed,
- M10 adjustment screws,
- material EN 1.4301, AISI 304 or EN 1.4404, AISI 316L,
- sheet thickness: 1.5 mm and 1.2 mm.



Water trap



Waste basket



Sand basket

Grating of the floor drain

(Ø200 mm) D200 DN75 V1/H1, DN110 V1/H1

Mesh grating, with 25 x 25mm mesh, with R13 anti-slip surface according to DIN 51130. Meets the requirements of load class L15 according to EN 1253.

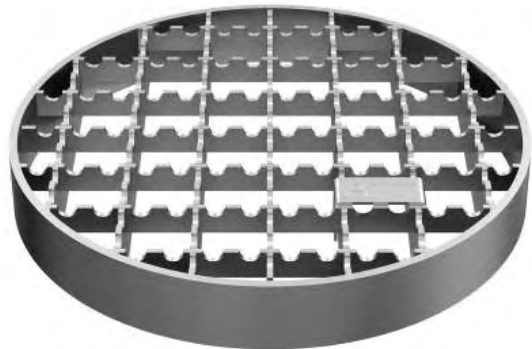

Slab grate with side gap, easy to remove. R10 anti-slip surface in accordance with DIN 51130. Meets the requirements of load class M125 in accordance with EN 1253.



Solid plate grate with gasket: gas-tight and water-tight; with suction cup. R10 anti-slip surface in accordance with DIN 51130. Meets the requirements of class M125 load class in accordance with EN 1253.



Ladder grate with smooth, non-slip surface R9 in accordance with DIN 51130. Meets the requirements of load class M125 in accordance with EN 1253. Complete welding in accordance with EHEDG compliant.



Single-part H. Design round floor drain (Ø260 mm) D260 DN110 V1/H1

ATT stainless steel floor drain features:



Vertical outlet DN75



Horizontal outlet DN110

- the drain is manufactured according to EN 1253 and EHEDG guidelines
- round shape,
- upper part of the body DN260 mm,
- hygienically deep-pressed body without sharp corners or elements,
- bottom body diameter: 193 mm,
- flow rate V1 - 3.0 l/s, H1 - 2.1 l/s
- siphon with EPDM gasket
- height of the water column is 50 mm,
- waste basket (capacity 1l) with handle,
- top edge brushed,
- M10 adjustment screws,
- material EN 1.4301, AISI 304 or EN 1.4404, AISI 316L,
- sheet thickness: 1.5 mm.



Siphons



Waste basket



Sand basket

Grating of the floor drain (Ø260 mm) D260 DN110 V1/H1

Mesh grating, with 25 x 25mm mesh, with R13 anti-slip surface according to DIN 51130. Meets the requirements of load class L15 according to EN 1253.

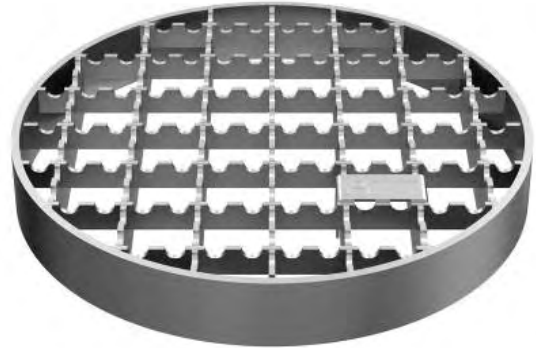

Slab grate with side gap, easy to remove. R10 anti-slip surface in accordance with DIN 51130. Meets the requirements of load class M125 in accordance with EN 1253.



Solid plate grate with gasket: gas-tight and water-tight; with suction cup. R10 anti-slip surface in accordance with DIN 51130. Meets the requirements of class M125 load class in accordance with EN 1253.



Ladder grate with smooth, non-slip surface R9 in accordance with DIN 51130. Meets the requirements of load class M125 in accordance with EN 1253. Complete welding in accordance with EHEDG compliant.



Single-part H. Design round floor drain (Ø300 mm) D300 DN110 V1/H1, DN160 V1/H1

ATT stainless steel floor drain features:



Vertical outlet DN110 or DN160



Horizontal outlet DN110 or DN160

- the drain is manufactured according to EN 1253 and EHEDG guidelines
- round shape,
- upper part of the body DN 300 mm,
- hygienically deep-pressed body without sharp corners or elements,
- bottom body diameter: 255 mm,
- no fluid backing up in the floor drain's body
- flow rate 5.7 l/s.
- siphon with EPDM gasket
- height of the water column is 50 mm,
- waste basket (capacity 2,9 l) with handle,
- top edge brushed,
- M10 adjustment screws,
- material EN 1.4301, AISI 304 or EN 1.4404, AISI 316L,
- sheet thickness: 1.5 mm.



Siphon



Waste basket



Sand basket

Grating of the floor drain

(Ø300 mm) D300 DN110 V1/H1, DN160 V1/H1

Mesh grating, with 25 x 25mm mesh, with R13 anti-slip surface according to DIN 51130. Meets the requirements of load class L15 according to EN 1253.

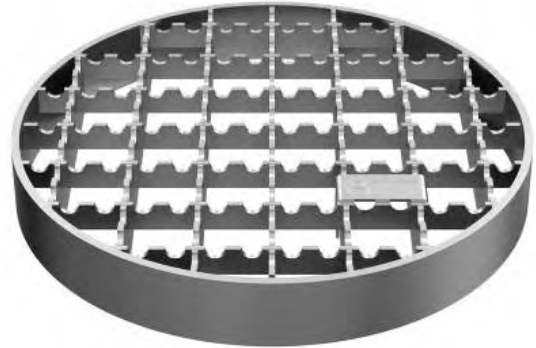

Slab grate with side gap, easy to remove. R10 anti-slip surface in accordance with DIN 51130. Meets the requirements of load class M125 in accordance with EN 1253.



Solid plate grate with gasket: gas-tight and water-tight; with suction cup. R10 anti-slip surface in accordance with DIN 51130. Meets the requirements of class M125 load class in accordance with EN 1253.



Ladder grate with smooth, non-slip surface R9 in accordance with DIN 51130. Meets the requirements of load class M125 in accordance with EN 1253. Complete welding in accordance with EHEDG compliant.



Two-part H. Design round floor drain (Ø200 mm) D200 DN75 V2/H2, DN110 V2/H2V2/H2

ATT stainless steel floor drain features:



Vertical outlet DN75 or DN110



Horizontal outlet DN75 or DN110

- the drain is manufactured according to EN 1253 and EHEDG guidelines
- round shape,
- upper part of the body DN200 mm,
- hygienically deep-pressed body without sharp corners or elements,
- bottom body diameter: 193 mm,
- height adjustable from 75 to 135 mm, possibility of rotation 360° and tilting by 6°,
- no fluid backing up in the floor drain's body
- flow rate 2.1 l/s
- siphon with EPDM gasket
- height of the water column is 50 mm,
- waste basket (capacity 0.45l) with handle,
- top edge brushed,
- M10 adjustment screws,
- material EN 1.4301, AISI 304 or EN 1.4404, AISI 316L,
- sheet thickness: 1.5 mm and 1.2 mm.



Siphon



Waste basket



Sand basket

Grating of the floor drain (Ø200 mm) D200 DN75 V2/H2, DN110

Mesh grating, with 25 x 25mm mesh, with R13 anti-slip surface according to DIN 51130. Meets the requirements of load class L15 according to EN 1253.

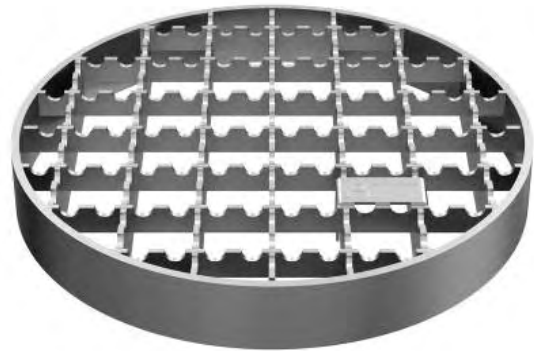

Slab grate with side gap, easy to remove. R10 anti-slip surface in accordance with DIN 51130. Meets the requirements of load class M125 in accordance with EN 1253.



Solid plate grate with gasket: gas-tight and water-tight; with suction cup. R10 anti-slip surface in accordance with DIN 51130. Meets the requirements of class M125 load class in accordance with EN 1253.



Ladder grate with smooth, non-slip surface R9 in accordance with DIN 51130. Meets the requirements of load class M125 in accordance with EN 1253. Complete welding in accordance with EHEDG compliant.



Two-part H. Design round floor drain (Ø260 mm) D260 DN110 V2/H2

ATT stainless steel floor drain features:



Vertical outlet DN110



Horizontal outlet DN110

- the drain is manufactured according to EN 1253 and EHEDG guidelines
- round shape,
- upper part of the body DN 260 mm,
- hygienically deep-pressed body without sharp corners or elements,
- bottom body diameter: 193mm,
- height adjustable from 75 to 150 mm, possibility of rotation 360° and tilting by 6°,
- flow rate V1 - 3.0 l/s, H1 - 2.1 l/s
- siphon with EPDM gasket
- height of the water column is 50 mm
- waste basket (capacity 1 l) with handle,
- top edge brushed,
- M10 adjustment screws,
- material EN 1.4301, AISI 304 or EN 1.4404, AISI 316L,
- sheet thickness: 1.5 mm.



Siphon

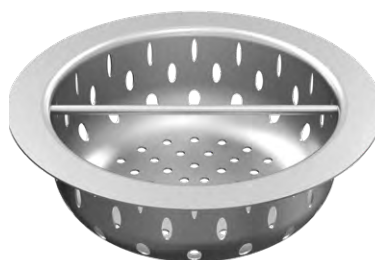

Waste basket



Sand basket

Grating of the floor drain (Ø260 mm) D260 DN110 V2/H2

Mesh grating, with 25 x 25mm mesh, with R13 anti-slip surface according to DIN 51130. Meets the requirements of load class L15 according to EN 1253.

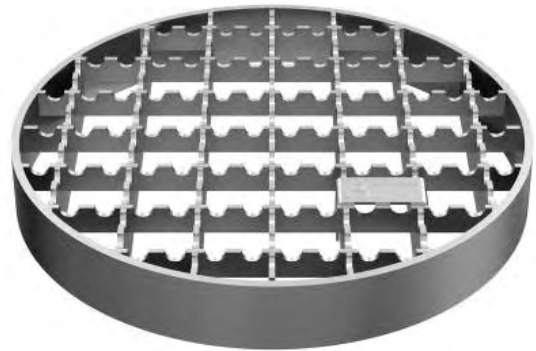

Slab grate with side gap, easy to remove. R10 anti-slip surface in accordance with DIN 51130. Meets the requirements of load class M125 in accordance with EN 1253.



Solid plate grate with gasket: gas-tight and water-tight; with suction cup. R10 anti-slip surface in accordance with DIN 51130. Meets the requirements of class M125 load class in accordance with EN 1253.



Ladder grate with smooth, non-slip surface R9 in accordance with DIN 51130. Meets the requirements of load class M125 in accordance with EN 1253. Complete welding in accordance with EHEDG compliant.



Two-part H. Design round floor drain (Ø300 mm) D300 DN110 V2/H2, DN160 V2/H2

ATT stainless steel floor drain features:



Vertical outlet DN110 or DN160



Horizontal outlet DN110 or DN160

- the drain is manufactured according to EN 1253 and EHEDG guidelines
- round shape,
- upper part of the body DN300 mm,
- hygienically deep-pressed body without sharp corners or elements,
- bottom body diameter: 255 mm
- height adjustable from 75 to 145 mm, possibility of rotation 360° and tilting by 6°,
- no fluid backing up in the floor drain's body
- flow rate 5.7 l/s.
- siphon with EPDM gasket
- height of the water column is 50 mm,
- waste basket (capacity 2,9 l) with handle,
- top edge brushed,
- M10 adjustment screws,
- material EN 1.4301, AISI 304 or EN 1.4404, AISI 316L,
- sheet thickness: 1.5 mm and 1.2 mm.



Siphon



Waste basket



Sand basket

Grating of the floor drain

(Ø300 mm) D300 DN110 V2/H2, DN160 V2/H2

Mesh grating, with 25 x 25mm mesh, with R13 anti-slip surface according to DIN 51130. Meets the requirements of load class L15 according to EN 1253.

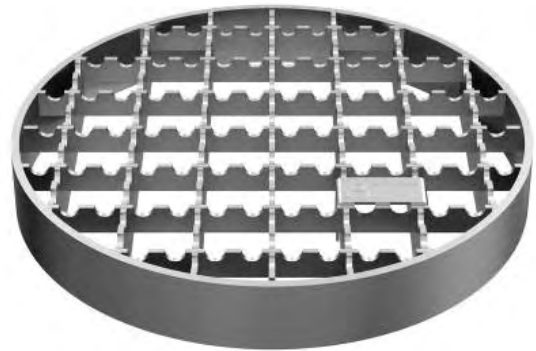

Slab grate with side gap, easy to remove. R10 anti-slip surface in accordance with DIN 51130. Meets the requirements of load class M125 in accordance with EN 1253.



Solid plate grate with gasket: gas-tight and water-tight; with suction cup. R10 anti-slip surface in accordance with DIN 51130. Meets the requirements of class M125 load class in accordance with EN 1253.



Ladder grate with smooth, non-slip surface R9 in accordance with DIN 51130. Meets the requirements of load class M125 in accordance with EN 1253. Complete welding in accordance with EHEDG compliant.



Slot channel S60



- The profile is completely open. There is no need for additional gratings.
- S60 channel dimension: external width 60 mm, slot width 20 mm.
- S48 channel dimension: external width 48 mm, slot width 8 mm.
- Minimum height: 45 mm.
- Standard slope: 0.5% - 1%/m.
- Selection of the drain depending on the amount of drained medium.
- Edge filling: epoxy or flat bar depending on charge and temperature.
- Top edge brushed.
- Product pickled and passivated.
- Stainless steel, material EN 1.4301, AISI 304 or EN 1.4404, AISI 316L.
- Sheet thickness: 1.5 mm and 2 mm.

Sample section drawing:

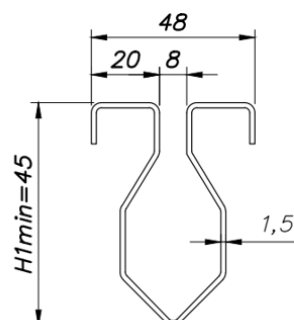
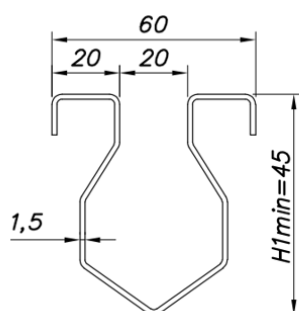

Shallow flat bottom channel



- Channel is designed with shallow flat bottom.
- Minimum external width: 120 mm.
- Channels of 190 mm width and wider are possible to be designed without extension of the outlet.
- Minimum height: 52 mm.
- Standard slope: 0.5% - 1%/m.
- Selection of the drain depending on the amount of drained medium.
- Edge filling: epoxy or flat bar depending on charge and temperature.
- Top edge brushed.
- Product pickled and passivated.
- Stainless steel, material EN 1.4301, AISI 304 or EN 1.4404, AISI 316L.
- Sheet thickness: 1.5 mm and 2 mm.

Sample section drawing:

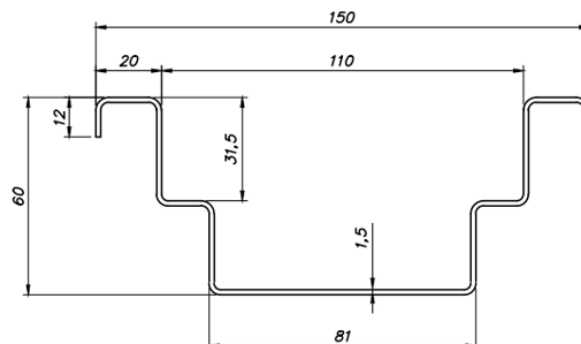

V-shaped bottom channel

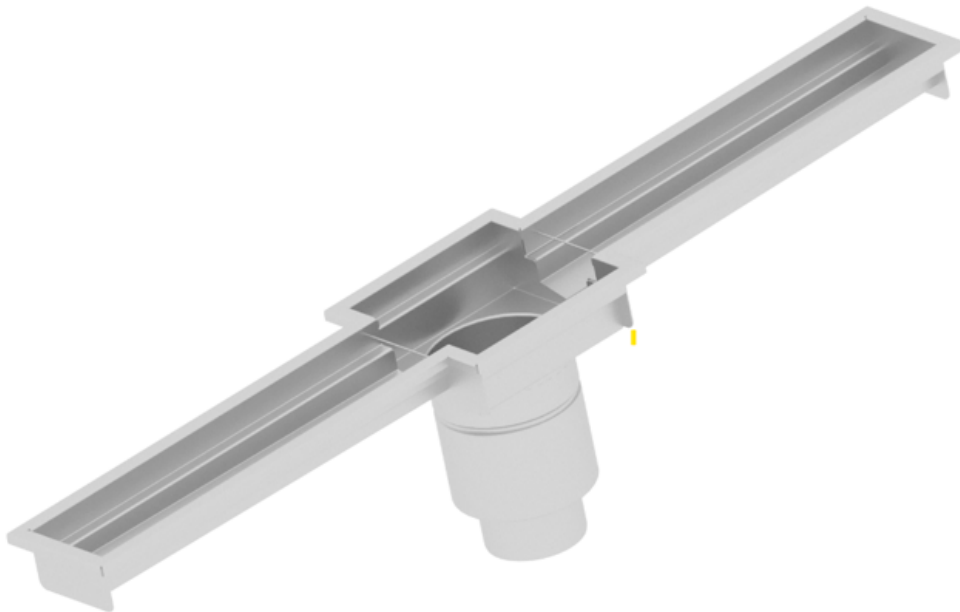

- Channel is designed with V-shaped bottom.
- Minimum external width: 120 mm.
- Channels of 190 mm width and wider are possible to be designed without extension of the outlet.
- Minimum height: 60 mm.
- Standard slope: 0.5% - 1%/m.
- Selection of the drain depending on the amount of drained medium.
- Edge filling: epoxy or flat bar depending on charge and temperature.
- Top edge brushed.
- Product pickled and passivated.
- Stainless steel, material EN 1.4301, AISI 304 or EN 1.4404, AISI 316L.
- Sheet thickness: 1.5 mm and 2 mm.
- Designed in accordance with European Hygienic Engineering and Design Group guidelines

Sample section drawing:

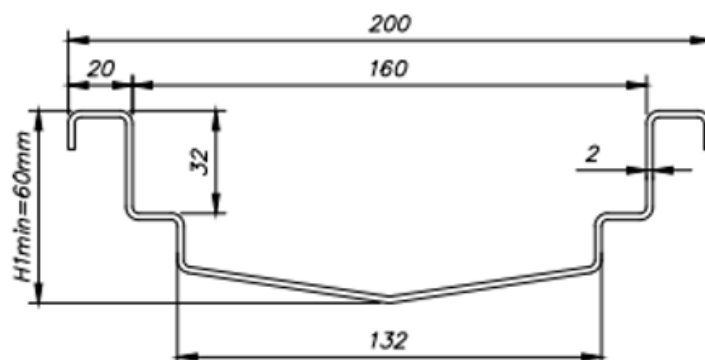

Gratings for V-shaped and flat bottom

Mesh gratings with 25 x 25 mm mesh, with R13 anti-slip surface in accordance with DIN 51130. Meets the requirements of load class up to C250 in accordance with EN 1433.

Plate gratings with R9 anti-slip surface in accordance with DIN 51130. Meets the requirements of load class up to D400 in accordance with EN 1433. Optionally, can be equipped with hinges.

Ladder grate with R11 anti-slip or smooth surface in accordance with DIN 51130. Meets the requirements of load class up to D400 in accordance with EN 1433. Continuous welding in accordance with EHEDG guidelines. Optionally, can be equipped with hinges.

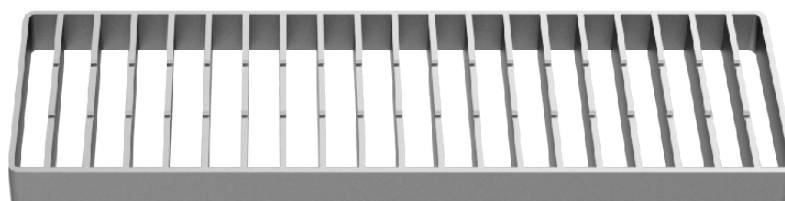
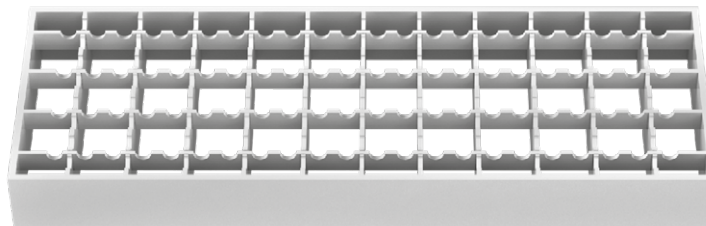

Round H. Design hygienic channels

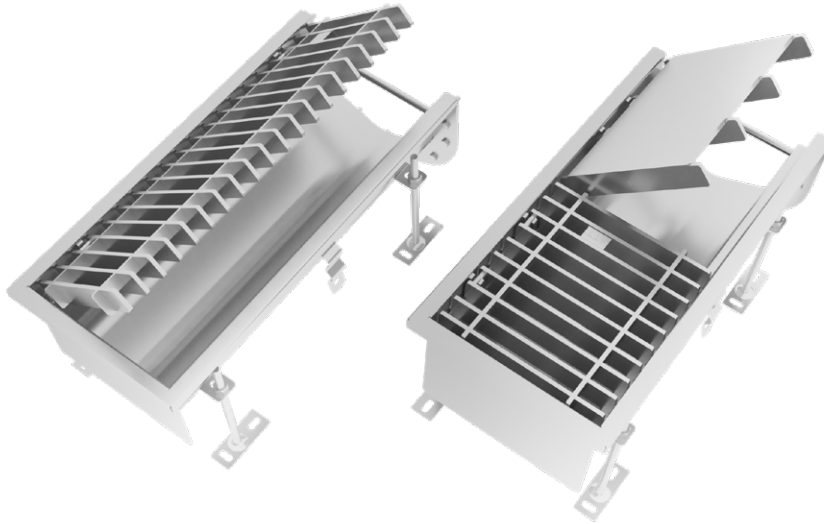

- Channel is designed with hygienic rounded bottom.
- Minimum external width: 180 mm.
- Channels of 190 mm width and wider are possible to be designed without extension of the outlet.
- Minimum height: 100 mm.
- Standard slope: 0.5% - 1%/m.
- Selection of the drain depending on the amount of drained medium.
- Edge filling: epoxy or flat bar depending on charge and temperature.
- Top edge brushed.
- Product pickled and passivated.
- Stainless steel, material EN 1.4301, AISI 304 or EN 1.4404, AISI 316L.
- Sheet thickness: 2 mm.
- Designed in accordance with European Hygienic Engineering and Design Group guidelines

Sample section drawing:

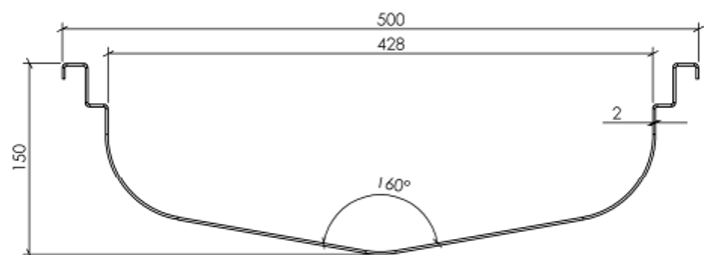
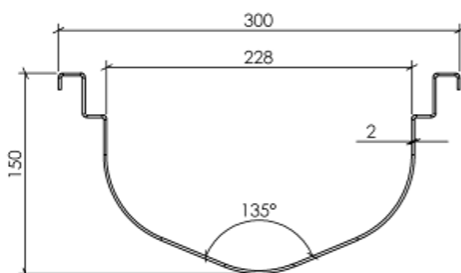

Grating for round H. Design hygienic channel

Plate gratings with R9 anti-slip surface in accordance with DIN 51130. Meets the requirements of load class up to D400 in accordance with EN 1433. Optionally, can be equipped with hinges.

Ladder grate with R11 anti-slip or smooth surface in accordance with DIN 51130. Meets the requirements of load class up to D400 in accordance with EN 1433. Continuous welding in accordance with EHEDG guidelines. Optionally, can be equipped with hinges.

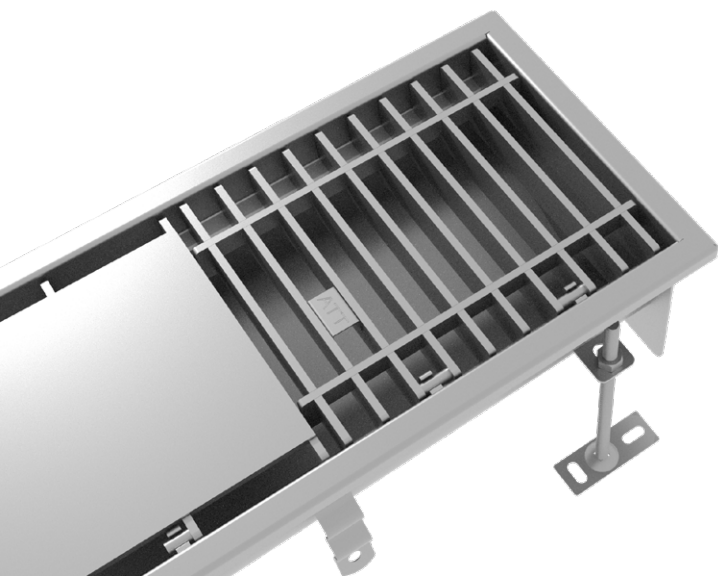
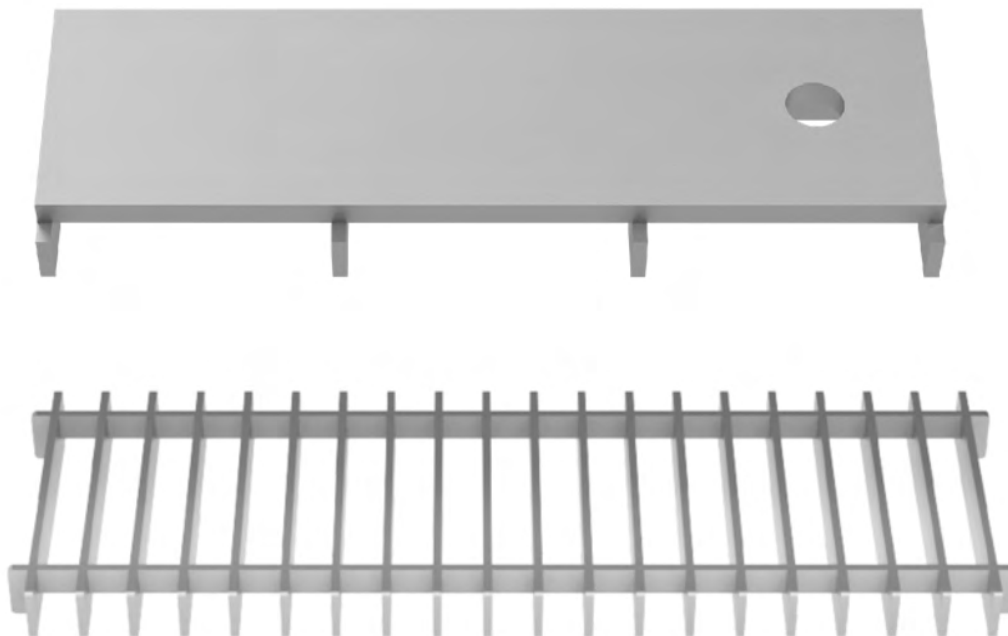



Stainless Steel Engineering®

www.attinox.com
www.bim.att.eu

